

WE OPEN
— THE —
DOORS
to the
FUTURE

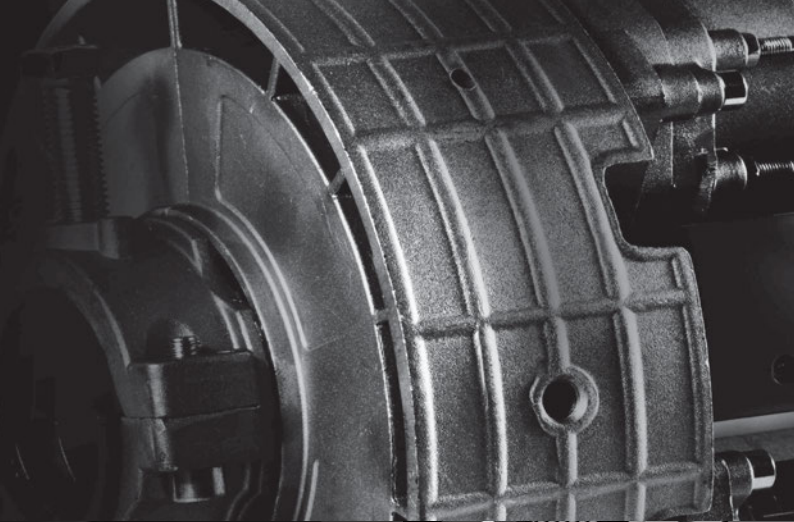

move[®]
automation

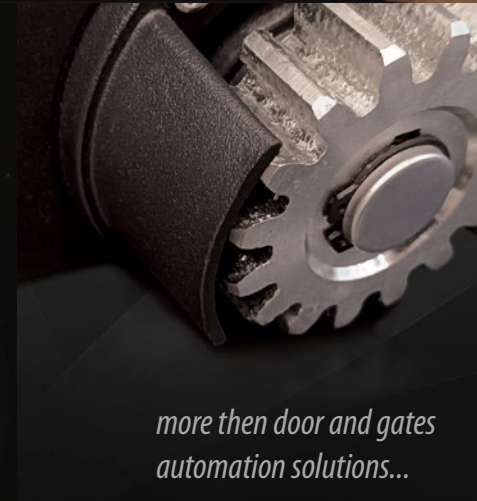
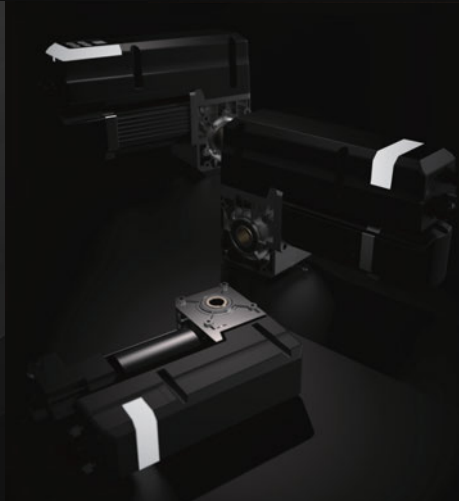
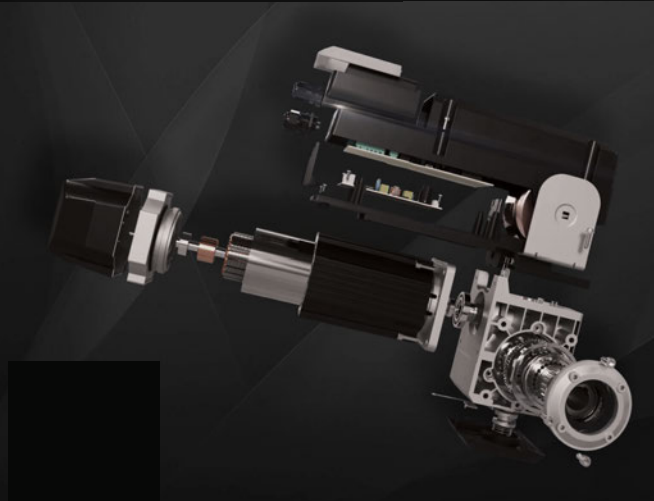

*more than door and gates
automation solutions...*

DAPORTAS Distributeur officiel



FORCE⁺

Para portas seccionadas ou basculantes até 16m²
 ES Para puertas seccionales o basculantes de hasta 16m²
 EN For sectional and tilting doors up to 16m²
 FR Pour portes sectionnelles ou basculantes jusqu'à 16m²



	FORCE ⁺ 600	FORCE ⁺ 1000	1000 speed	FORCE ⁺ 1200
	≥ 9m ²	≥ 14m ²	≥ 16m ²	≥ 16m ²
	90 Kg	140 Kg	160 Kg	160 Kg
	160 mm/seg	160 mm/seg	200 mm/seg	160 mm/seg



KIT

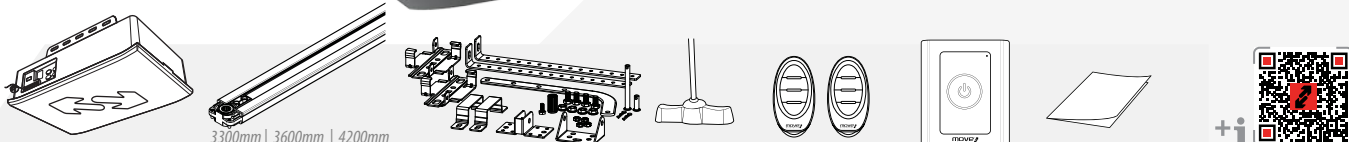

base

Para portas seccionadas até 40m²
 ES Para puertas seccionales hasta 40m²
 EN For sectional doors up to 40m²
 FR Pour portes sectionnelles jusqu'à 40m²

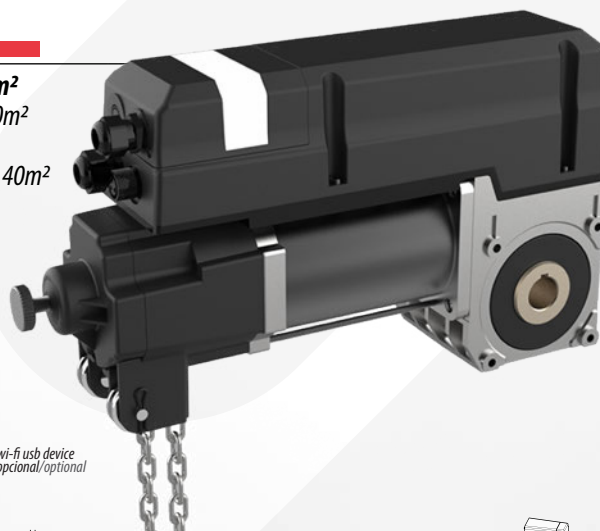

	base35	base50	base70	base120
	≤ 18m ²	≤ 24m ²	≤ 28m ²	≤ 40m ²
	≤ 234 Kg	312 Kg	364 Kg	540 Kg
	≤ 14m ²	≤ 20m ²	≤ 24m ²	≤ 36m ²
	182 Kg	260 Kg	312 Kg	468 Kg
	≤ 5 m	≥ 8 m	≥ 8 m	≥ 10 m
		25,4 θ		25,4 θ / 31,75 θ

base 35
KIT

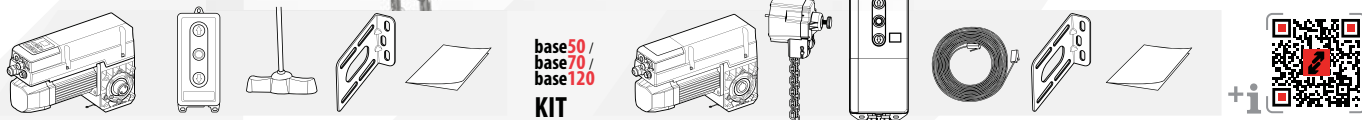

base50 / base70 / base120
KIT

Slider⁺

Para portões de correr com peso até 800 kg
 ES Para puertas correderas hasta 800 kg
 EN For sliding gates weighing up to 800 kg
 FR Pour portails coulissants jusqu'à 800 kg

Slider⁺ 500 | Slider⁺ 800

	500 Kg	800 Kg
	156 mm/seg	186 mm/seg



Slider ind.



Para portões de correr com peso até 2000 kg
 ES Para puertas correderas hasta 2000 kg
 EN For sliding gates weighing up to 2000 kg
 FR Pour portails coulissants jusqu'à 2000 kg

Slider ind. 1000 24V | Slider ind. 1500 | Slider ind. 2000

	1000 Kg	1500 Kg	2000 Kg
	12 m/min	12 m/min	12 m/min



KIT

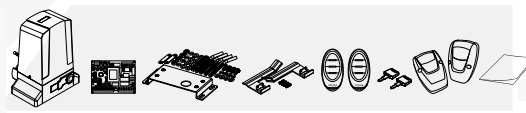
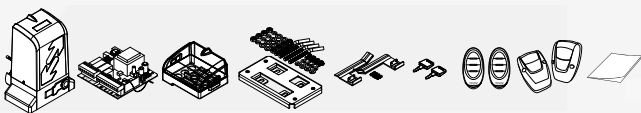

Select⁺



Para portões de batente até 4 metros por folha.
ES Para puertas batiente de hasta 4 metros por hoja.
EN For swing gates up to 4 meters per leaf
FR Pour portails battants jusqu'à 4 mètres par vantail.



Select⁺300 | Select⁺400 | Select⁺600

	2 m	3 m	4 m
	350 Kg (230V/110V) / 300 Kg (24V)		
	1,8 cm/seg (230V/110V) / 2 cm/seg (24V)		

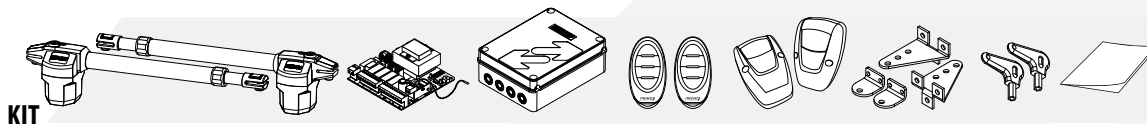

KIT

bend >



Para portões de batente até 4 metros por folha.
ES Para puertas batiente de hasta 4 metros por hoja.
EN For swing gates up to 4 meters per leaf
FR Pour portails battants jusqu'à 4 mètres par vantail.



bend >

	4 m (230V)	2,5 m (24V)
	400 Kg (230V)	500 Kg (24V)



KIT

TigerBolt



Para grades de enrolar até 6m e até 360 Kg
ES Para Puertas enrollables hasta 6 metros y hasta 360Kg
EN For rolling shutters up to 6 meters and up to 360Kg
FR Pour portes enrollables allant jusqu'à 6 mètres et 360 kg



Bolt 160 | Bolt 360 | Tiger 420

	160 Kg	360 Kg	350 Kg
	≤ 6 m		
	10 RPM	9,5 RPM	
	∅ 60 mm	∅ 76 mm	
	∅ 200 mm	∅ 240 mm	

Lift /



Barreira uso intensivo com haste extensível até 6m
ES Barrera uso intensivo con asta extensible hasta 6m
EN Intensive use road barrier with extendable bar up to 6m
FR Barrière usage intensif avec lisse extensible jusqu'à 6m



KIT

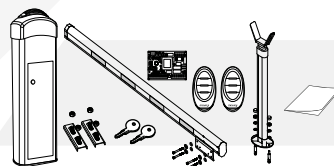



DAPORTAS

Distribuidor oficial de automatismos Move Automation
Distribuidor oficial de automatismos Move Automation
Distribuidor oficial d'automatismes Move Automation
Distributeur officiel d'automatismes Move Automation
Offizieller Vertriebspartner für Move Automation
Official distributor of Move Automation systems
Officiële distributeur van Move automatiseringssystemen
Distributore ufficiale di automazioni Move Automation

store@daportas.pt | info@daportas.es | info@daportas.fr | info@daportas.de

BOUTIQUE EN LIGNE



**FRANCE • MONACO • BELGIQUE
LUXEMBOURG • SUISSE**

Nos envois d'automatismes et d'accessoires sont effectués par le transporteur GLS, qui assure les livraisons dans toute l'Union Européenne, Monaco et Suisse sous 5 jours ouvrés. C'est notre partenaire de référence.

GLS.